

Precijet 6 level GN 1/1 electric oven

Ref. PI601E

PRECIJET THE ESSENTIAL

JetControl® : advanced injection technology

Integral TwinControl® : exclusive patented system doubling the essential oven functions

FastPAD® : touch control panel, intuitive and ergonomic

Intelligent cooking: AirControl® & CoreControl® for guaranteed cooking results

Full Cleaning System: cleaning and descaling system with automatic supply

Consobox: tracks the ovens historic consumption levels

TECHNICAL SPECIFICS

* FastPAD® control panel: intuitive and ergonomic comprising a large colour LCD tough screen and an optical coder button.

* Fitted with **AirControl® Concept**: variable ventilation speed, **Airdry®**, auto reverse impellor for uniform browning, ventilation provided by 1 fan

* Fitted with **CoreControl® Concept**: The power of the oven is automatically adjusted to suit the load being cooked for more precise temperature control.

* The oven can be preheated out of hours

* Automatically switches to energy saving mode after a period of inactivity

* **7 cooking modes:**

- Convection from 0 to 250°C
- Saturated steam: steam to 98°C
- Combined from 30 to 250°C (with humidity adjustable from 0 to 99%)
- Low temperature: steam from 30 to 97°C
- High temperature steam: steam from 99 to 105 °C
- Regeneration
- Delta T

* **Automatic mode:**

- 80 preloaded recipes as standard with the option to adjust the degree of cooking and the colouration
- It is possible to create entirely personalised recipes
- Displayed as text or as pictures via the library within the oven
- Recipes are classified by family and or in « my recipes »

* **Functions**

- Automatic oven cavity cooling: for improved reactivity
- Humidifier: provides instant steam (shot of vapour): ideal for bread
- Airdry® : rapid drying: rapid product dehydration
- Hold function: cools and holds temperature after cooking: avoids the surface of the product drying out
- Timer: programmable cooking time for each stage: provides flexibility during service

* **Service mode**

- USB interface as standard
- Tracking software kit supplied with the oven
- Transfer recipes and photographs via a computer
- Automatic rinse possible between cooking operations, replaces the spray hose
- Parameters can be modified to give maximum personalisation
- Visual Diagnostic System: interactive screen intended for technicians

* **Equipment**

- Cooking cavity with radiused corners conforms to HACCP requirements
- Cool double athermic glazed door with left or right hand rotation of the handle to open and a simple push closure. Opens to 180°
- Halogen cavity lighting

* **Standard supply**

- 6 level runners with 80mm gaps
- Multi point removable rotisserie core probe 3mm dia. 100mm long

ACCESSORIES (optional)

- * Removable core probe: sous vide model 1.5mm dia 100mm long
- * Independant spray hose kit
- * Energy economiser kit
- * Right hinged door
- * Stands







NORMS: Conforms to:

EN 60-335-2-42: European norm relating to the safety of electrical appliances.
(French norm: classification index C 73-842).

IP 25 and IK 9: Protection indices.

XP U 60-010: Hygiene.



-  ELECTRICAL connection
-  COLD WATER
-  DRAIN
-  Chimney with choke
-  Exit for surplus vapour

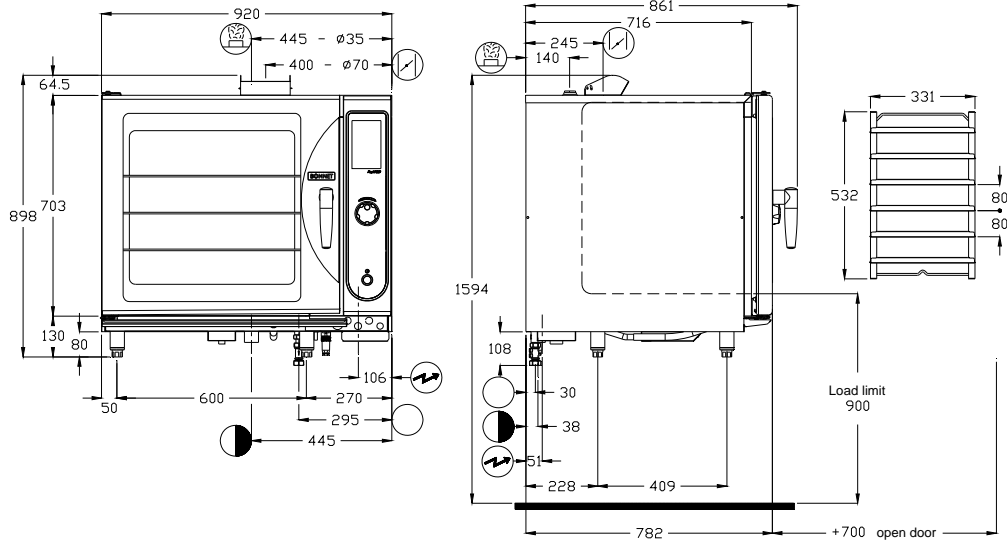

MODEL

B-FM10:611PI

DIMENSIONS (mm)

External	Height 898; Width 920; Depth 861
Height oven + legs	1594
Cavity	Height 552; Width 630; Depth 535

CAPACITIES

Usable oven capacity (dm ³)	186
GN 1/1 ovenware (325 x 530)	6
Max. depth of containers (mm)	65
Space between levels (mm)	80
Maximum capacity (kg)	24

PACKAGED (mm)

Height	1020
Width x Depth	1020 x 900

WEIGHT (kg)

130

CLEARANCES

Left: 4 cm; Right: 50 cm

TEMPERATURE RANGE

0 to 250°C

CORE TEMPERATURE RANGE

0 to 99°C

TIMER

99 hours

 **ELECTRICITY** (Three phase 415V / 50 / 3+N+E)

Voltage	I. Max (A)	Power (kW)
415V 3Na.c.	14.8	10.0

 **COLD WATER**

Pressure (Min / Max)	150/600 kPa (1.5 bar / 6 bar)
Max temperature	30°C
Nature	Filtered to 50 microns
Hardness	Soft Max. 40°TH (28°e, 22°h, 400ppm)
Conductivity	Min 20 µS/cm
Connection	20/27 threaded

 **DRAIN**

Condensate temperature	Approx. 98°C
Connection	Vertical exit 40/49 threaded stainless (G 1"1/2)

CONSTRUCTION

Cavity and Cladding	18-10 stainless
---------------------	-----------------

EQUIPMENT TYPE

Against a wall - Not stackable

ELECTRICAL CONNECTION

Electrical inlet 757mm from floor